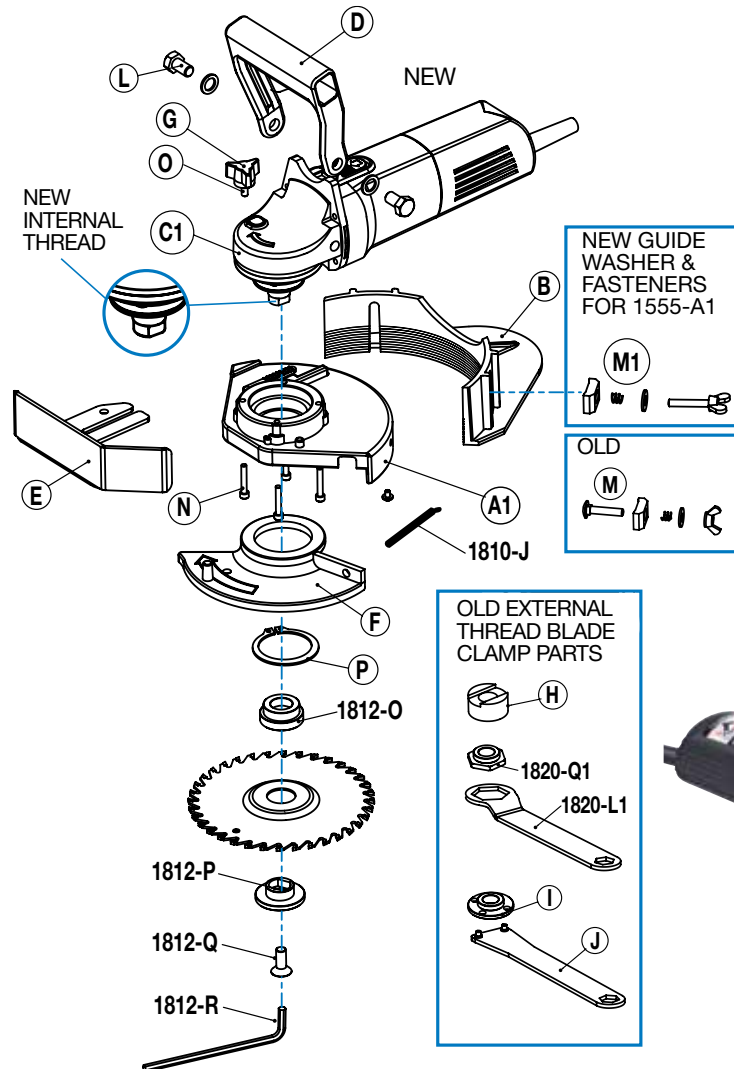
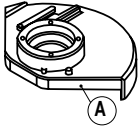

No. 555 Multi-Undercut Saw

NOTE:
No. 1500-C
No. 1500-C1
Power Units
Discontinued -
no replacement
motors available
for No. 555.

DISCONTINUED PARTS / REPLACE WITH:

DISCONTINUED:
 NO. 1555-A OLD HOUSING

REPLACE WITH:
 NO. 1555-A1 NEW HOUSING AND
 NO. 1555-M1 NEW GUIDE WASHER
 & FASTENER SET (8). (ORDER BOTH.)

NO. 555 MULTI-UNDERCUT SAW

Order No.	Description
1555-A1	NEW Housing
1555-B	Height Adjuster
1555-C1**	NEW Power Unit, 120 volts (Discontinued)
1555-D	Plastic Handle
1555-E	Depth Gauge
1555-F	Blade Guard
1555-G	Three-Arm Knob
1555-H*	Blade Driver
1555-I*	OLD Blade Clamp Nut (Discontinued)
1555-J*	OLD Spanner Wrench
1555-K	Brush Set (2 - not shown)
1555-L	Handle Fastener Set (4)

1555-M	OLD Guide Washer & Fastener Set (10)
1555-M1	NEW Guide Washer & Fastener Set (8)
1555-N	Housing Fastener Set (4)
1555-O	Set Screw
1555-P	Snap Ring
1555-R	Carrying Case (not shown)
1555-S	Brush Holder Assembly (2) (not shown)
FOR BLUE HOUSING SAWS (OLD)	
1555-V	Toggle Switch (not shown)
FOR BLACK HOUSING SAWS (NEW)	
1555-V1	Marquardt Switch (not shown)
1555-W	Power Cord Strain Relief (not shown)

1555-X	Return Spring Screw Only (not shown)
1555-Z	Power Cord (not shown)
1810-J	Blade Guard Spring
1812-O**	Blade Spacer
1812-P**	Blade Clamp
1812-Q**	Blade Screw
1812-R**	Allen® Wrench
1820-L1*	OLD Hex Blade Wrench
1820-Q1*	OLD Hex Blade Clamp Nut
* For saws with 1555-C power unit (spindle w/external thread)	
** For saws with 1555-C1 power unit (spindle w/internal thread) produced after 12/30/2005	